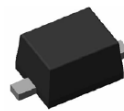

## Features

- 500mW Power Dissipation on FR-4 PCB
- Very Tight Tolerance on  $V_z$
- Ideally Suited for Automated Assembly Processes
- **Totally Lead-Free & Fully RoHS Compliant (Notes 1 & 2)**
- **Halogen and Antimony Free. "Green" Device (Note 3)**

## Mechanical Data

- Case: SOD323F
- Case Material: Molded Plastic, "Green Molding Compound".  
UL Flammability Classification Rating 94V-0
- Moisture Sensitivity: Level 1 per J-STD-020
- Terminal Connections: Cathode Band
- Terminals: Finish – Matte Tin Annealed over Copper Alloy  
Leadframe. Solderable per MIL-STD-202, Method 208 Ⓔ
- Weight: 0.004 grams (Approximate)

**SOD323F**

Top View

## Ordering Information (Note 4)

Part Number	Compliance	Case	Packaging
DDZxx(x)SF-7*	Commercial	SOD323F	3,000/Tape & Reel

\*Add "-7" to the appropriate type number in Electrical Characteristics Table on Page 2. Example: DDZ10BSF-7.

- Notes:
1. No purposely added lead. Fully EU Directive 2002/95/EC (RoHS) & 2011/65/EU (RoHS 2) compliant.
  2. See [http://www.diodes.com/quality/lead\\_free.html](http://www.diodes.com/quality/lead_free.html) for more information about Diodes Incorporated's definitions of Halogen- and Antimony-free, "Green" and Lead-free.
  3. Halogen- and Antimony-free "Green" products are defined as those which contain <900ppm bromine, <900ppm chlorine (<1500ppm total Br + Cl) and <1000ppm antimony compounds.
  4. For packaging details, go to our website at <http://www.diodes.com/products/packages.html>.

## Marking Information



XX = Product Type Marking Code  
(See Electrical Characteristics Table)  
YM = Date Code Marking  
Y = Year (ex: D = 2016)  
M = Month (ex: 9 = September)

### Date Code Key

Year	2010	2011	2012	2013	2014	2015	2016	2017	2018	2019	2020
Code	X	Y	Z	A	B	C	D	E	F	G	H

Month	Jan	Feb	Mar	Apr	May	Jun	Jul	Aug	Sep	Oct	Nov	Dec
Code	1	2	3	4	5	6	7	8	9	O	N	D

**Maximum Ratings** (@T<sub>A</sub> = +25°C, unless otherwise specified.)

Characteristic	Symbol	Value	Unit
Forward Voltage @I <sub>F</sub> = 10mA	V <sub>F</sub>	0.9	V

**Thermal Characteristics**

Characteristic	Symbol	Value	Unit
Power Dissipation (Note 5)	P <sub>D</sub>	500	mW
Thermal Resistance, Junction to Ambient Air (Note 5)	R <sub>θJA</sub>	250	°C/W
Operating and Storage Temperature Range	T <sub>J</sub> , T <sub>STG</sub>	-65 to +150	°C

**Electrical Characteristics** (@T<sub>A</sub> = +25°C, unless otherwise specified.)

Type Number	Marking Code	Zener Voltage Range (Note 6)			Maximum Zener Impedance f = 1kHz	Maximum Reverse Current (Note 7)	
		V <sub>Z</sub> @ I <sub>ZT</sub>		Z <sub>zT</sub> @ I <sub>ZT</sub>		I <sub>R</sub>	@ V <sub>R</sub>
		Min (V)	Max (V)	I <sub>ZT</sub> mA	Ω	μA	V
DDZ2V4ASF	4C	2.33	2.52	20	100	120	1
DDZ2V4BSF	KD	2.43	2.63	20	100	120	1
DDZ2V7ASF	4E	2.54	2.75	20	110	120	1
DDZ2V7BSF	KE	2.69	2.91	20	110	120	1
DDZ3V0ASF	4F	2.85	3.07	20	120	50	1
DDZ3V0BSF	KF	3.01	3.22	20	120	50	1
DDZ3V3ASF	4G	3.16	3.38	20	130	20	1
DDZ3V3BSF	KG	3.32	3.53	20	130	20	1
DDZ3V6ASF	4H	3.45	3.69	20	130	10	1
DDZ3V6BSF	KH	3.60	3.84	20	130	10	1
DDZ3V9ASF	4J	3.74	4.01	20	130	10	1
DDZ3V9BSF	KJ	3.89	4.16	20	130	10	1
DDZ4V3ASF	4K	4.04	4.29	20	130	10	1
DDZ4V3BSF	KK	4.17	4.43	20	130	10	1
DDZ4V3CSF	YK	4.30	4.57	20	130	10	1
DDZ4V7ASF	4L	4.44	4.68	20	130	10	1
DDZ4V7BSF	KL	4.55	4.80	20	130	10	1
DDZ4V7CSF	YL	4.68	4.93	20	130	10	1
DDZ5V1ASF	4M	4.81	5.07	20	130	7.5	2
DDZ5V1BSF	KM	4.94	5.20	20	130	7.5	2
DDZ5V1CSF	YM	5.09	5.37	20	130	7.5	2
DDZ5V6ASF	4N	5.28	5.55	20	80	7.5	2
DDZ5V6BSF	KN	5.45	5.73	20	80	7.5	2
DDZ5V6CSF	YN	5.61	5.91	20	80	7.5	2
DDZ6V2ASF	4O	5.78	6.09	20	50	7.5	3
DDZ6V2BSF	KO	5.96	6.27	20	50	7.5	3
DDZ6V2CSF	YO	6.12	6.44	20	50	7.5	3
DDZ6V8ASF	4P	6.29	6.63	20	30	7.5	4
DDZ6V8BSF	KP	6.49	6.83	20	30	7.5	4
DDZ6V8CSF	YP	6.66	7.01	20	30	7.5	4
DDZ7V5ASF	4Q	6.85	7.22	20	30	7.5	4
DDZ7V5BSF	KQ	7.07	7.45	20	30	7.5	4
DDZ7V5CSF	YQ	7.29	7.67	20	30	7.5	4
DDZ8V2ASF	4R	7.53	7.92	20	30	7.5	7.15
DDZ8V2BSF	KR	7.78	8.19	20	30	7.5	7.39
DDZ8V2CSF	YR	8.03	8.45	20	30	7.5	7.63

- Notes:
- Device mounted on FR-4 PCB with 10mm x 10mm pad, board size 35mm x 25mm.
  - The Zener voltage is measured <40ms after power is supplied.
  - Short duration pulse test used to minimize self-heating effect.

**Electrical Characteristics** (Cont.) (@T<sub>A</sub> = +25°C, unless otherwise specified.)

Type Number	Marking Code	Zener Voltage Range (Note 6)			Maximum Zener Impedance f = 1kHz	Maximum Reverse Current (Note 7)	
		V <sub>Z</sub> @ I <sub>ZT</sub>		I <sub>R</sub>		@ V <sub>R</sub>	
		Min (V)	Max (V)	I <sub>ZT</sub> mA	Z <sub>ZT</sub> @ I <sub>ZT</sub> Ω	μA	V
DDZ9V1ASF	4S	8.29	8.73	20	30	7.5	7.88
DDZ9V1BSF	KS	8.57	9.01	20	30	7.5	8.14
DDZ9V1CSF	YS	8.83	9.30	20	30	7.5	8.39
DDZ10ASF	4T	9.12	9.59	20	30	7.5	8.66
DDZ10BSF	KT	9.41	9.90	20	30	7.5	8.94
DDZ10CSF	YT	9.70	10.20	20	30	7.5	9.22
DDZ10DSF	7T	9.94	10.44	20	30	7.5	9.44
DDZ11ASF	4U	10.18	10.71	10	30	0.07	9.67
DDZ11BSF	KU	10.50	11.05	10	30	0.07	9.98
DDZ11CSF	YU	10.82	11.38	10	30	0.07	10.28
DDZ12ASF	4V	11.13	11.71	10	35	0.07	10.60
DDZ12BSF	KV	11.44	12.03	10	30	0.07	10.90
DDZ12CSF	YV	11.74	12.35	10	35	0.07	11.20
DDZ13ASF	4W	12.11	12.75	10	35	0.07	11.50
DDZ13BSF	KW	12.55	13.21	10	35	0.07	11.90
DDZ13CSF	YW	12.99	13.66	10	35	0.07	12.30
DDZ15ASF	4X	13.44	14.13	10	40	0.07	12.80
DDZ15BSF	KX	13.89	14.62	10	40	0.07	13.20
DDZ15CSF	YX	14.35	15.09	10	40	0.07	13.60
DDZ16ASF	4Y	14.80	15.57	10	40	0.07	14.10
DDZ16BSF	KY	15.25	16.04	10	40	0.07	14.50
DDZ16CSF	YY	15.69	16.51	10	40	0.07	14.90
DDZ18ASF	4Z	16.22	17.06	10	45	0.07	15.40
DDZ18BSF	KZ	16.82	17.70	10	45	0.07	16.00
DDZ18CSF	YZ	17.42	18.33	10	45	0.07	16.50
DDZ20ASF	RJ	18.05	18.96	10	50	0.07	17.10
DDZ20BSF	ZJ	18.63	19.59	10	50	0.07	17.70
DDZ20CSF	PJ	19.23	20.22	10	50	0.07	17.70
DDZ20DSF	2J	19.72	20.72	10	50	0.07	18.70
DDZ22ASF	RK	20.15	21.20	5	55	0.07	19.10
DDZ22BSF	ZK	20.64	21.71	5	55	0.07	19.60
DDZ22CSF	PK	21.08	22.17	5	55	0.07	20.00
DDZ22DSF	2K	21.52	22.63	5	55	0.07	20.40
DDZ24ASF	RL	22.05	23.18	5	60	0.07	20.90
DDZ24BSF	ZL	22.61	23.77	5	60	0.07	21.50
DDZ24CSF	PL	23.12	24.31	5	60	0.07	22.00
DDZ24DSF	2L	23.63	24.85	5	60	0.07	22.40
DDZ27ASF	RM	24.26	25.52	5	70	0.07	23.00
DDZ27BSF	ZM	24.97	26.26	5	70	0.07	23.70
DDZ27CSF	PM	25.63	26.95	5	70	0.07	24.30
DDZ27DSF	2M	26.29	27.64	5	70	0.07	25.00
DDZ30ASF	RN	26.99	28.39	5	80	0.07	25.60
DDZ30BSF	ZN	27.70	29.13	5	80	0.07	26.00
DDZ30CSF	PN	28.36	29.82	5	55	0.07	26.90
DDZ30DSF	2N	29.02	30.51	5	80	0.07	27.60
DDZ33ASF	RO	29.68	31.22	5	80	0.07	28.20
DDZ33BSF	ZO	30.32	31.88	5	80	0.07	28.80
DDZ33CSF	PO	30.90	32.50	5	65	0.07	29.40
DDZ33DSF	2O	31.49	33.11	5	65	0.07	29.90
DDZ36ASF	RP	32.14	33.79	5	90	0.07	30.50
DDZ36BSF	ZP	32.79	34.49	5	90	0.07	31.20
DDZ36CSF	PP	33.40	35.13	5	75	0.07	31.70
DDZ36DSF	2P	34.01	35.77	5	90	0.07	32.30
DDZ39ASF	RQ	34.68	36.47	5	85	0.2	30.00
DDZ39BSF	ZQ	35.36	37.19	5	85	0.2	30.00
DDZ39CSF	PQ	36.00	37.85	5	85	0.2	30.00
DDZ39DSF	2Q	36.63	38.52	5	85	0.2	30.00

Notes: 6. The Zener voltage is measured <40ms after power is supplied.  
7. Short duration pulse test used to minimize self-heating effect.

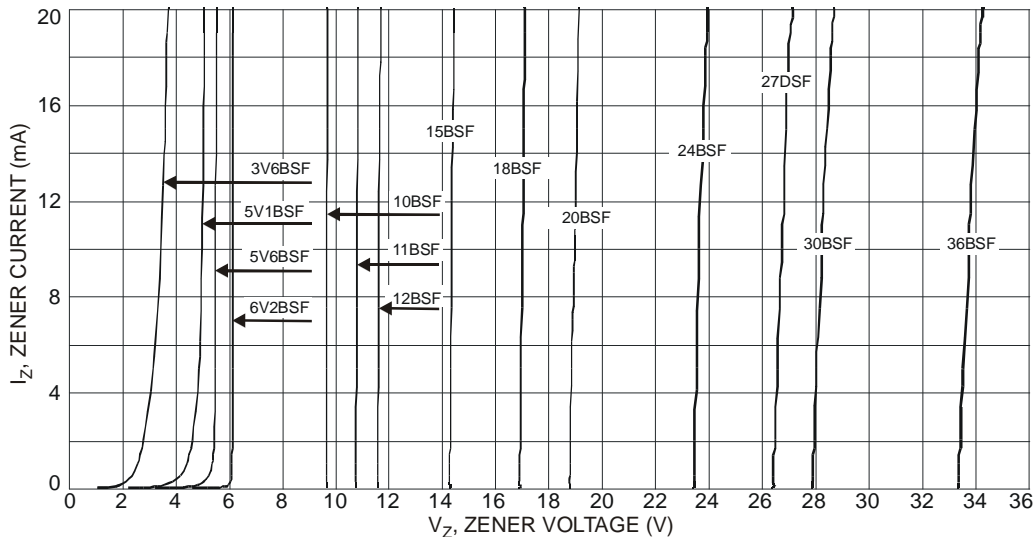
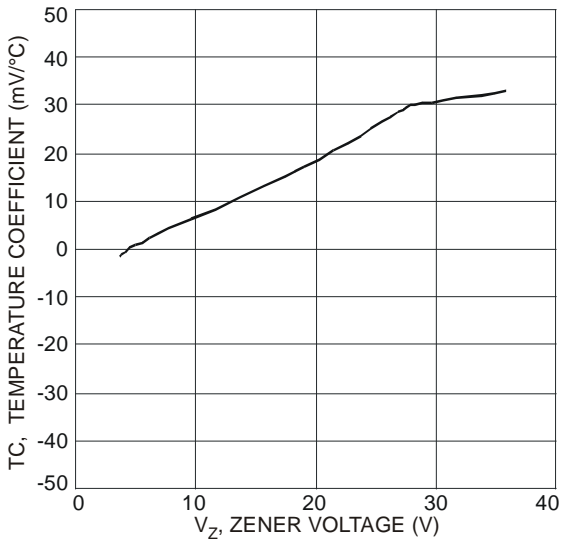
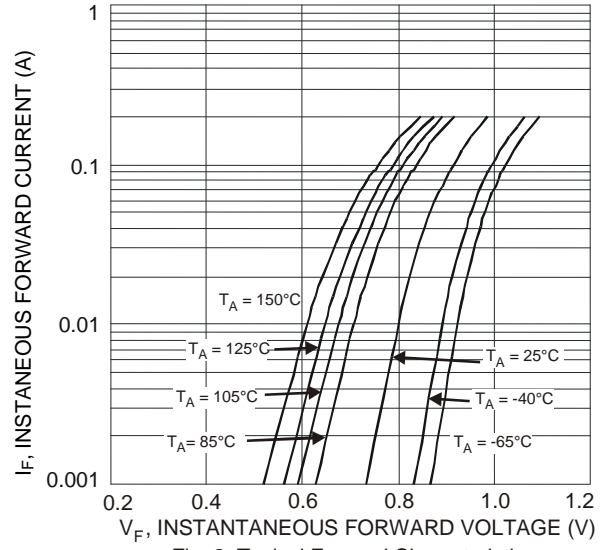
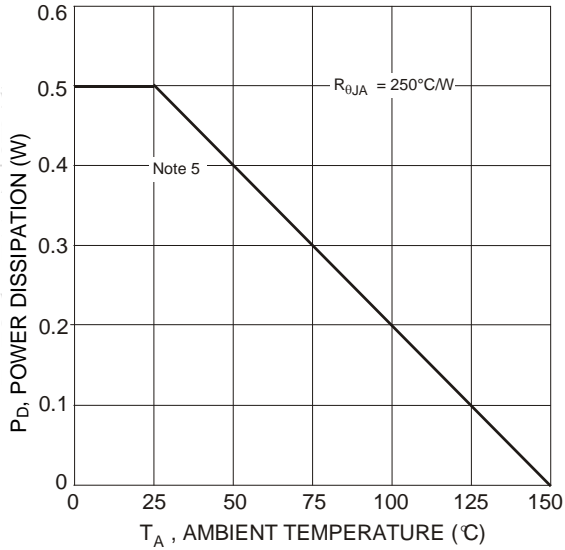

**Package Outline Dimensions**

Please see <http://www.diodes.com/package-outlines.html> for the latest version.

**SOD323F**

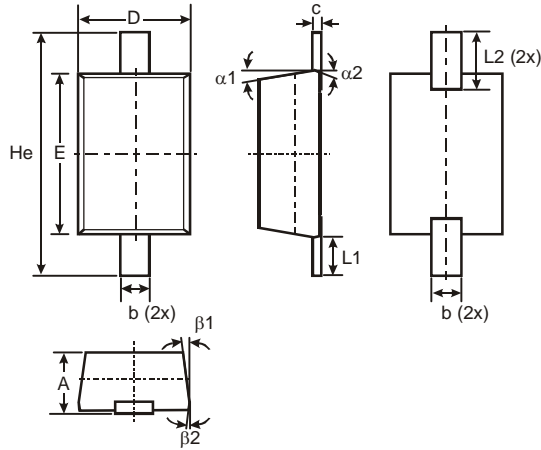

SOD323F			
Dim	Min	Max	Typ
A	0.60	0.75	–
b	0.25	0.35	–
c	0.05	0.26	–
D	1.15	1.35	1.25
E	1.60	1.80	1.70
He	2.30	2.70	2.50
L1	0.30	0.50	0.40
L2	0.41	0.61	0.51
$\alpha1$	–	–	7°
$\alpha2$	–	–	3°
$\beta1$	–	–	7°
$\beta2$	–	–	3°
All Dimensions in mm			

**Suggested Pad Layout**

Please see <http://www.diodes.com/package-outlines.html> for the latest version.

**SOD323F**

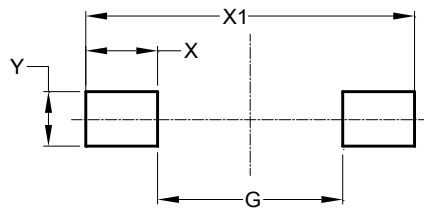

Dimensions	Value (in mm)
G	1.280
X	0.710
X1	2.700
Y	0.403

**IMPORTANT NOTICE**

DIODES INCORPORATED MAKES NO WARRANTY OF ANY KIND, EXPRESS OR IMPLIED, WITH REGARDS TO THIS DOCUMENT, INCLUDING, BUT NOT LIMITED TO, THE IMPLIED WARRANTIES OF MERCHANTABILITY AND FITNESS FOR A PARTICULAR PURPOSE (AND THEIR EQUIVALENTS UNDER THE LAWS OF ANY JURISDICTION).

Diodes Incorporated and its subsidiaries reserve the right to make modifications, enhancements, improvements, corrections or other changes without further notice to this document and any product described herein. Diodes Incorporated does not assume any liability arising out of the application or use of this document or any product described herein; neither does Diodes Incorporated convey any license under its patent or trademark rights, nor the rights of others. Any Customer or user of this document or products described herein in such applications shall assume all risks of such use and will agree to hold Diodes Incorporated and all the companies whose products are represented on Diodes Incorporated website, harmless against all damages.

Diodes Incorporated does not warrant or accept any liability whatsoever in respect of any products purchased through unauthorized sales channel. Should Customers purchase or use Diodes Incorporated products for any unintended or unauthorized application, Customers shall indemnify and hold Diodes Incorporated and its representatives harmless against all claims, damages, expenses, and attorney fees arising out of, directly or indirectly, any claim of personal injury or death associated with such unintended or unauthorized application.

Products described herein may be covered by one or more United States, international or foreign patents pending. Product names and markings noted herein may also be covered by one or more United States, international or foreign trademarks.

This document is written in English but may be translated into multiple languages for reference. Only the English version of this document is the final and determinative format released by Diodes Incorporated.

**LIFE SUPPORT**

Diodes Incorporated products are specifically not authorized for use as critical components in life support devices or systems without the express written approval of the Chief Executive Officer of Diodes Incorporated. As used herein:

A. Life support devices or systems are devices or systems which:

1. are intended to implant into the body, or
2. support or sustain life and whose failure to perform when properly used in accordance with instructions for use provided in the labeling can be reasonably expected to result in significant injury to the user.

B. A critical component is any component in a life support device or system whose failure to perform can be reasonably expected to cause the failure of the life support device or to affect its safety or effectiveness.

Customers represent that they have all necessary expertise in the safety and regulatory ramifications of their life support devices or systems, and acknowledge and agree that they are solely responsible for all legal, regulatory and safety-related requirements concerning their products and any use of Diodes Incorporated products in such safety-critical, life support devices or systems, notwithstanding any devices- or systems-related information or support that may be provided by Diodes Incorporated. Further, Customers must fully indemnify Diodes Incorporated and its representatives against any damages arising out of the use of Diodes Incorporated products in such safety-critical, life support devices or systems.

Copyright © 2016, Diodes Incorporated

**[www.diodes.com](http://www.diodes.com)**